



DIBA

TENSILE ARCHITECTURE

MOTORIZED PERGOLA SYSTEMS **LOCA**



ARDALAN TERRACE-TEHRAN



سایبان‌های باز بسنه‌شونده

Retractable Pergolas



ساپبان بازو بسنه شونده اردلان
فرم معلق . دی ۱۳۹۴ . تهران

Ardalan
retractable pergola
Hanging style
Jan 2016
Tehran.Iran





Retractable Pergola
 Orkideh Restaurant
 Standing System Inclined Style February 2016
 Motel Qoo, Mazandaran . Iran

سایبان
 بازوینتنه شویره
 رستوران ارکیدیه
 فرم شیب‌دار بابدنه شیبته‌ای . اسفند ۱۳۹۴ . منل قو



رسنوران لاپم
مجتمع تجاری گلستان. شهرک غرب
فرم شیب دار دوقلو. آذر ۱۳۹۵. تهران

LIME Cafdeeshop in
Golestan Shopping Center
Twin Standing System Inclined Style

Desember 2016

Shahrak-e-Gharb.Tehran.Iran





رستوران هتل تاج محل
فرم شیب دار دوقلو . آذر ۱۳۹۵ . تهران

Restaurant in Taj Mahal Hotel

Twin Standing System
Inclined Style **Desember 2016**
Sheikhbahaei St .Tehran.Iran



Dejavu Cafee & Restaurant
West Terrace

Standing System Inclined Style

Zaferanie.Tehran.Iran February 2016

رستوران دژاوو
نراس غربی . زعفرانیه
فرم شیب دار . بهمن ۱۳۹۵ . تهران





فدرت طراحی

the power of design









طرح‌های
فونی
circular
layout





تلفیق کارایی و زیبائی
the merge of
functionality
and elegance





آسایبتس
بیئتنتر
maximized
comfort





column-free
adaptable
canopies

سایبان‌های بدون ستون





Maximum shading حد اکثر سایه



رنگها و پارچه‌های سفارشی
custom colors and fabrics

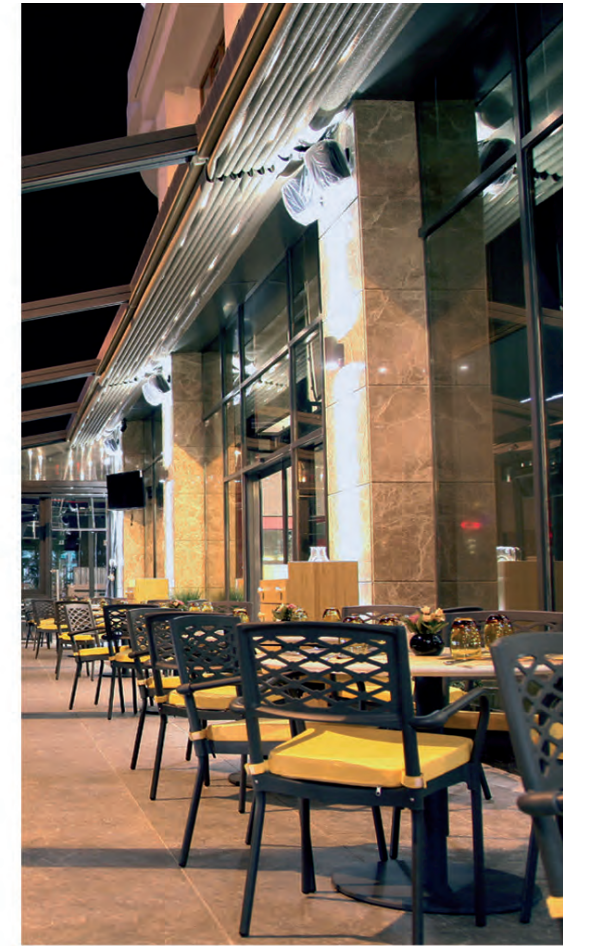

قابلیت اتصال به سازه‌ی موجود
retrofitting



Accentuating
الحقوق لذتها | simple pleasures



پوشش
وسیع
Vast coverage

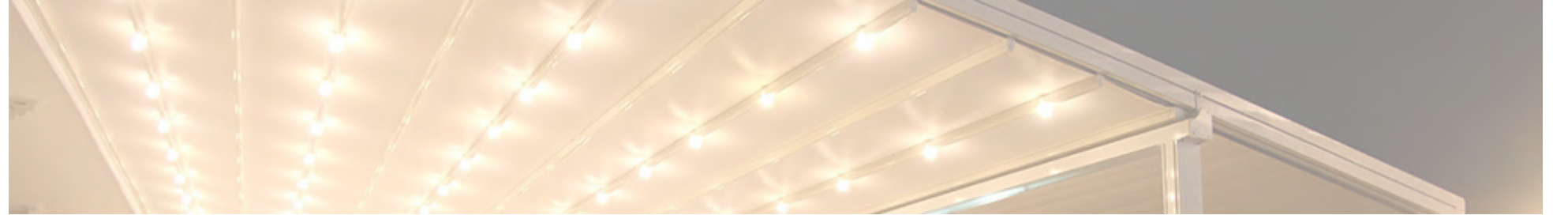





Breathtaking
aesthetics
نورپردازی دلنشین







Standing · bracket
and
hanging systems
in flat · inclined and
rounded styles

در ۳ حالت تخت · مایل و فتوی
سپس هی ایستاده · برکت دار و معلق







SUPPORTING PRODUCTS

VERTICAL STORE - ANGLE STORE - WIND STORE - RICCI



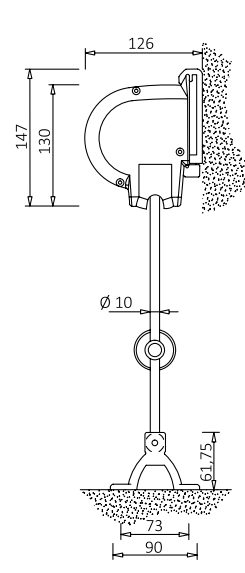
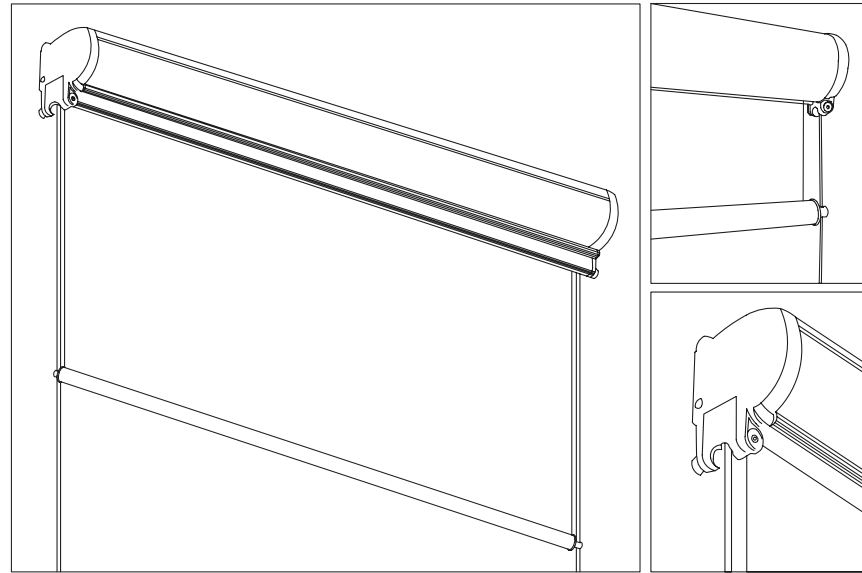

DUVAR MONTAJ DETAYI

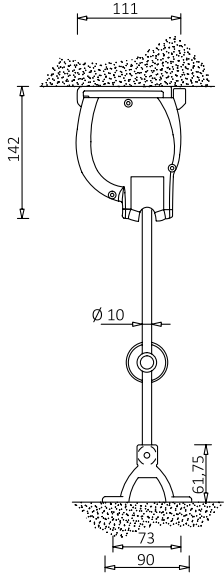

TAVAN MONTAJ DETAYI

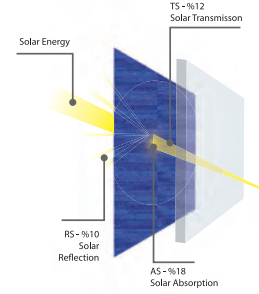

	Max.	Min.
(L) Width	480 cm	120 cm
(H) Height	250 cm	100 cm



Sun Sensor



Sun and Wind Sensor



Vibration Sensor



Remote Control



5 Years Warranty

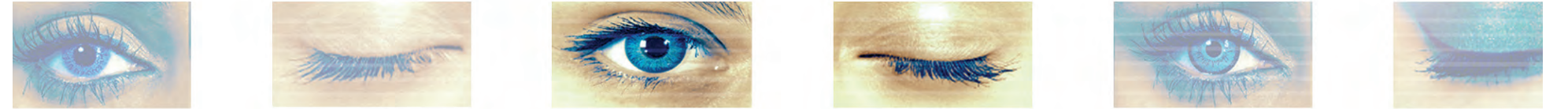

VERTICAL STORE

A vertical cassette shade suitable against the sun
 سایبان قرقراهی عمودی مناسب در برابر تابش آفتاب

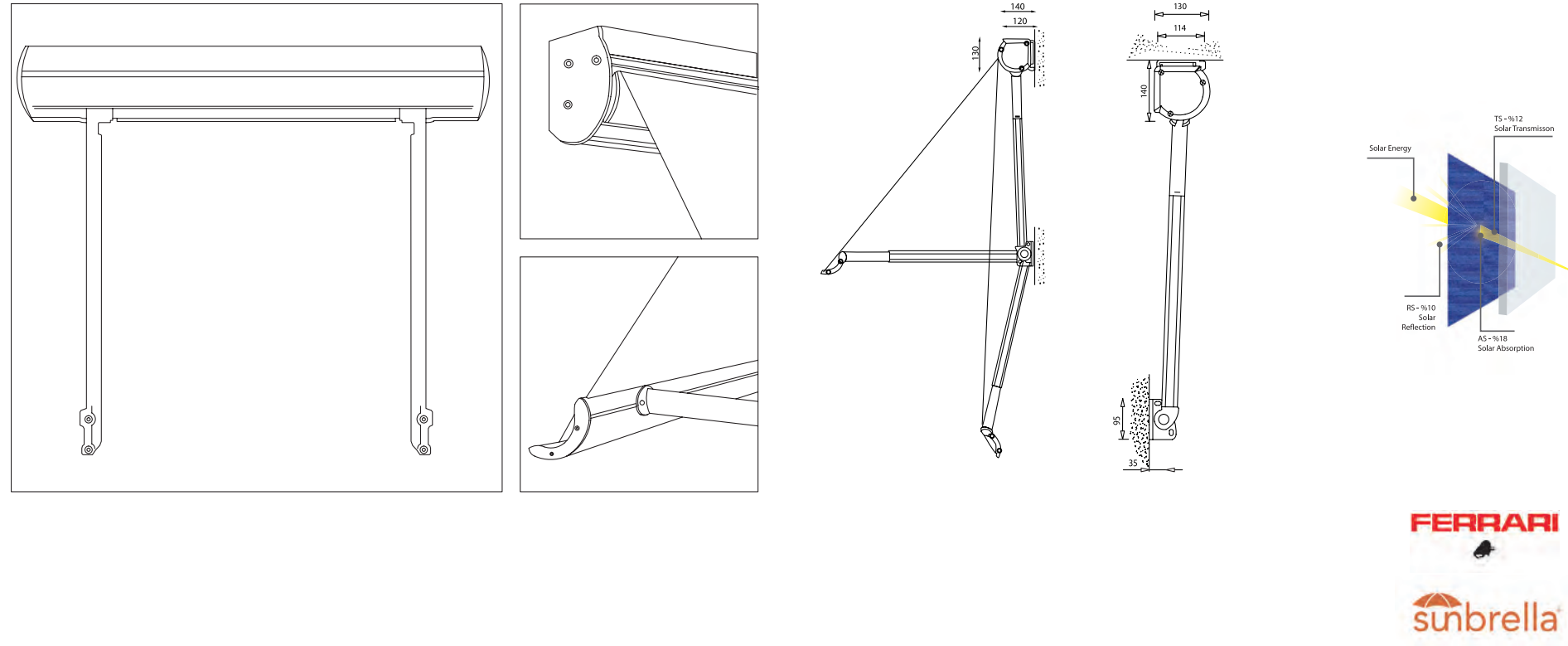

	Max.	Min.
(L) Width	480 cm	120 cm
(H) Height	320 cm	160 cm



ANGLE STORE

A canopy with an adjustable angle
سایبانی با زاویه‌ی قابل تنظیم

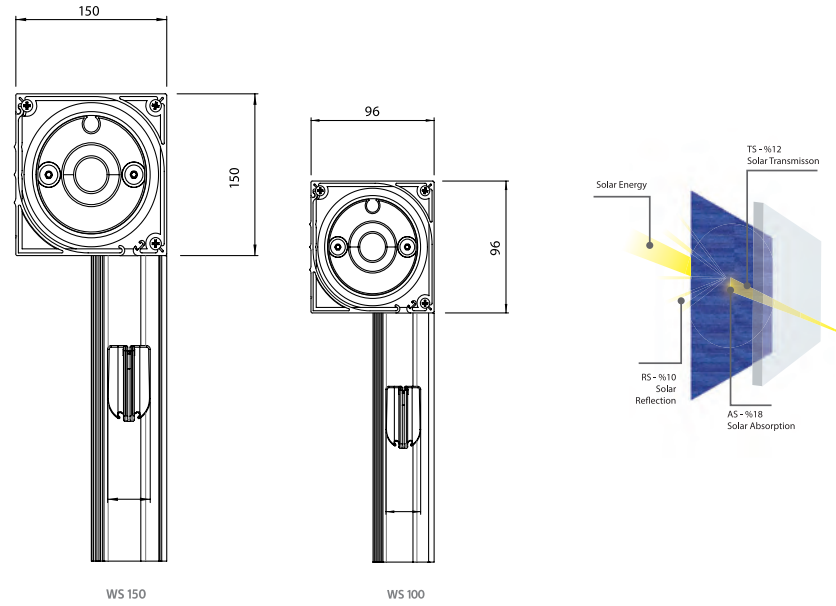
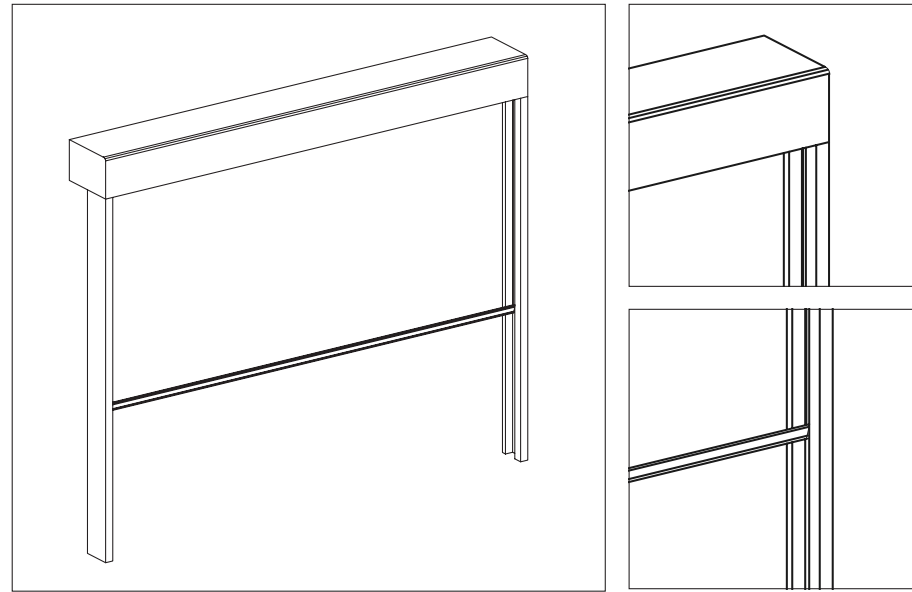

WIND STORE

A wind resistant canopy without restricting the view
 سایبان بادگیر بدون اختلال دید

	Max.	Min.
(L) Width	600 cm	100 cm
(H) Height	340 cm	100 cm



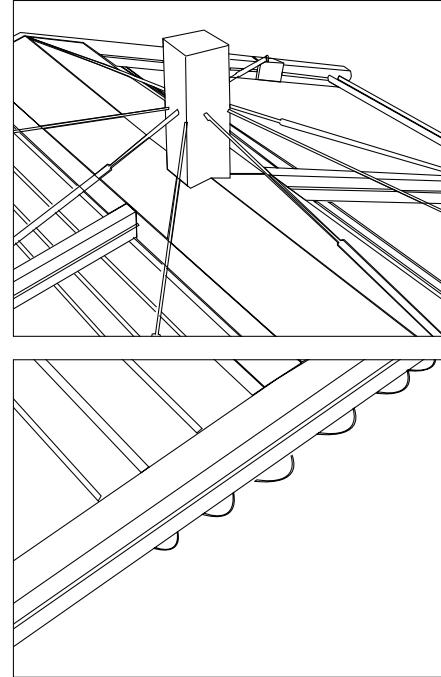
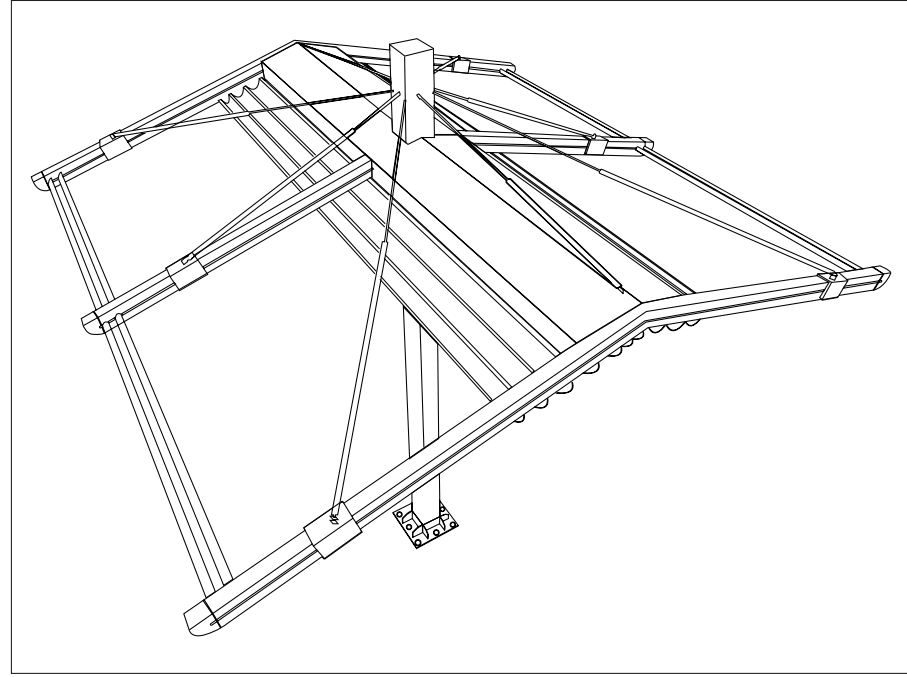

SIOEN

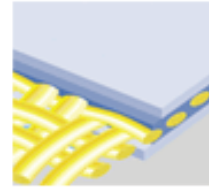

FERRARI

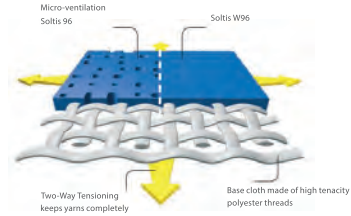

RICCI

A parasol fit for severe weather conditions
چتر آفتابی، مناسب شرایط نامساعد آب و هوایی

	Max.	Min.
Width	700 cm	100 cm
Projection	700 cm	100 cm



Sun Sensor



Sun and Wind Sensor



Vibration Sensor



Remote Control



5 Years Warranty

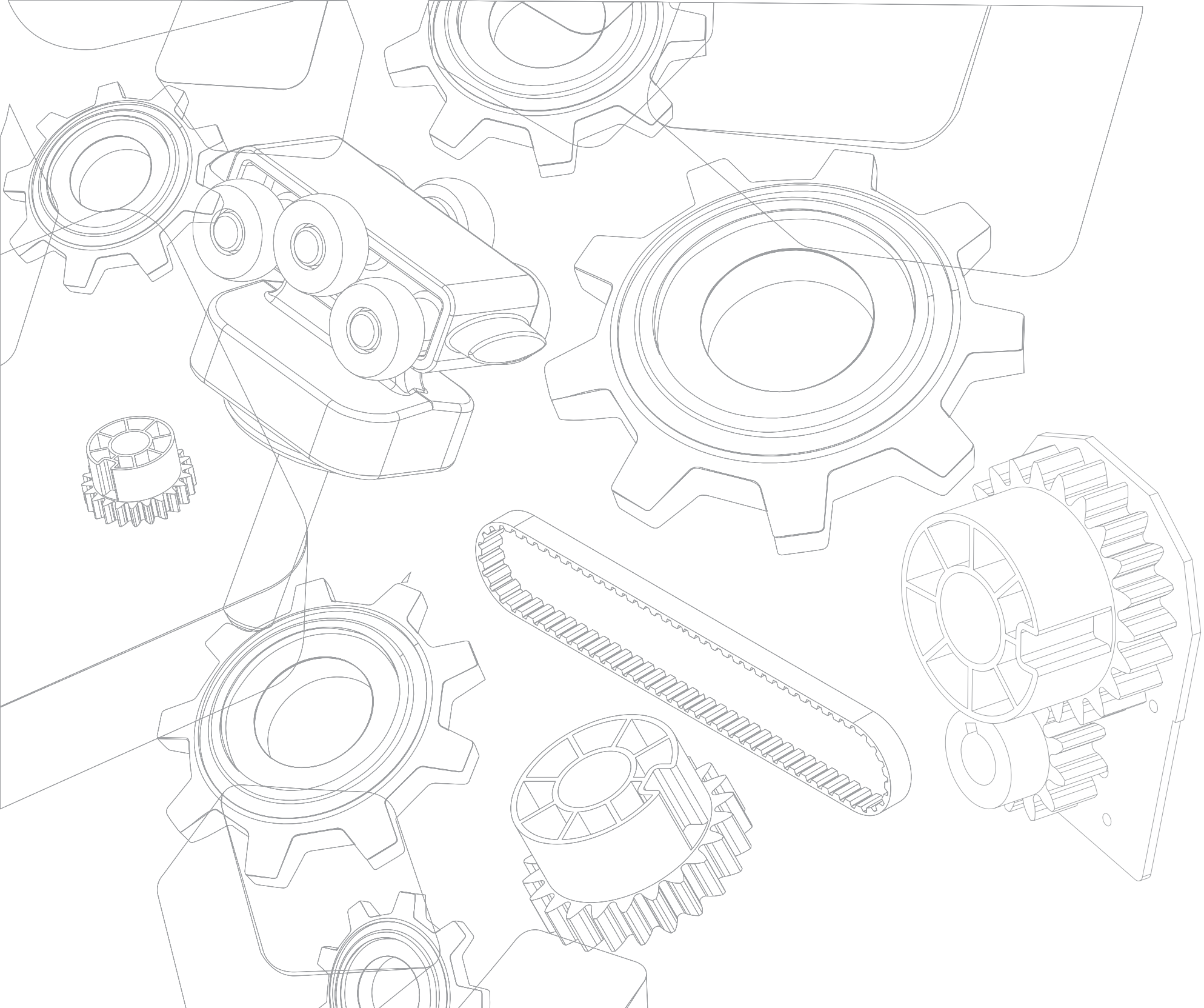

TECHNICAL INFORMATION

MOTOR SYSTEM

Somfy motor systems
Warrantied for 5 years

موتور سامفی
با ۵ سال وارانتی



Telis 1 RTS

Telis 4 RTS

Telis Modulis4 RTS

Telis 16

Remote Controls



Sun Sensor



Sun and Wind Sensor



Vibration Sensor

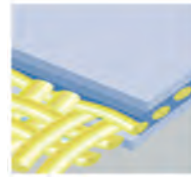

SIOEN

PVC-based

FERRARI

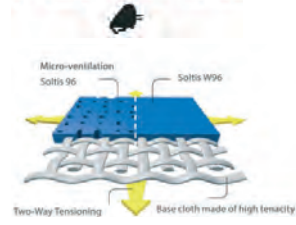

Micro-perforated Soltis



Acrylic



Acrylic



LIGHTING SYSTEM

Optional LED luminaries with remote control dimmer systems

نورپردازی سفارشی با سیستم تنظیم کنترل از راه دور



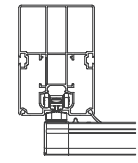

آب بندی ویژه
Rubber-sealed

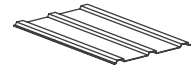

طرح های سقفی مدولار
Modular roofing designs

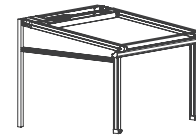

مقاوم در برابر باد و باران
Wind and rain resistant

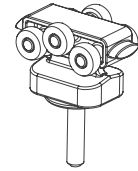

موتور ۶ چرخه
6-wheeled car

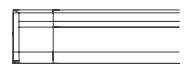

امکان نصب تیرهای جانبی
Applicable side beams



پوشش ۳ لایه ای
3-layered ceiling cover

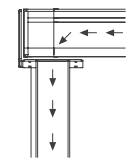

خروجی مخفی آب
Hidden water drainage

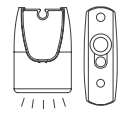

نورپردازی LED
LED Spot lightings



با وارانته لوکا
Loca warranted

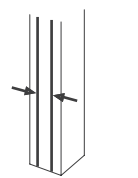

سیستم اتصالات یک پارچه
Integrated assembly system

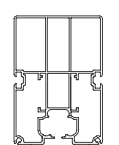

مقطع ریلی تقویت شده
Strengthened rail profile

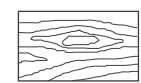

امکان روکش چوبی رنگ
برای سازه های آلومینیومی
Wood look coating for
the aluminium structures

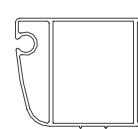

مقطع حرکتی مستحکم
Reinforced locomotive profile

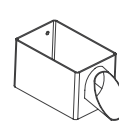

پایه فلزی
Metal roofing



امکان اتصال پوشش شیشه ای
Compliant glass systems

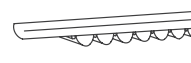

پوشش دکوراتیو سقف
Decorative ceiling cover

TECHNICAL INFORMATION

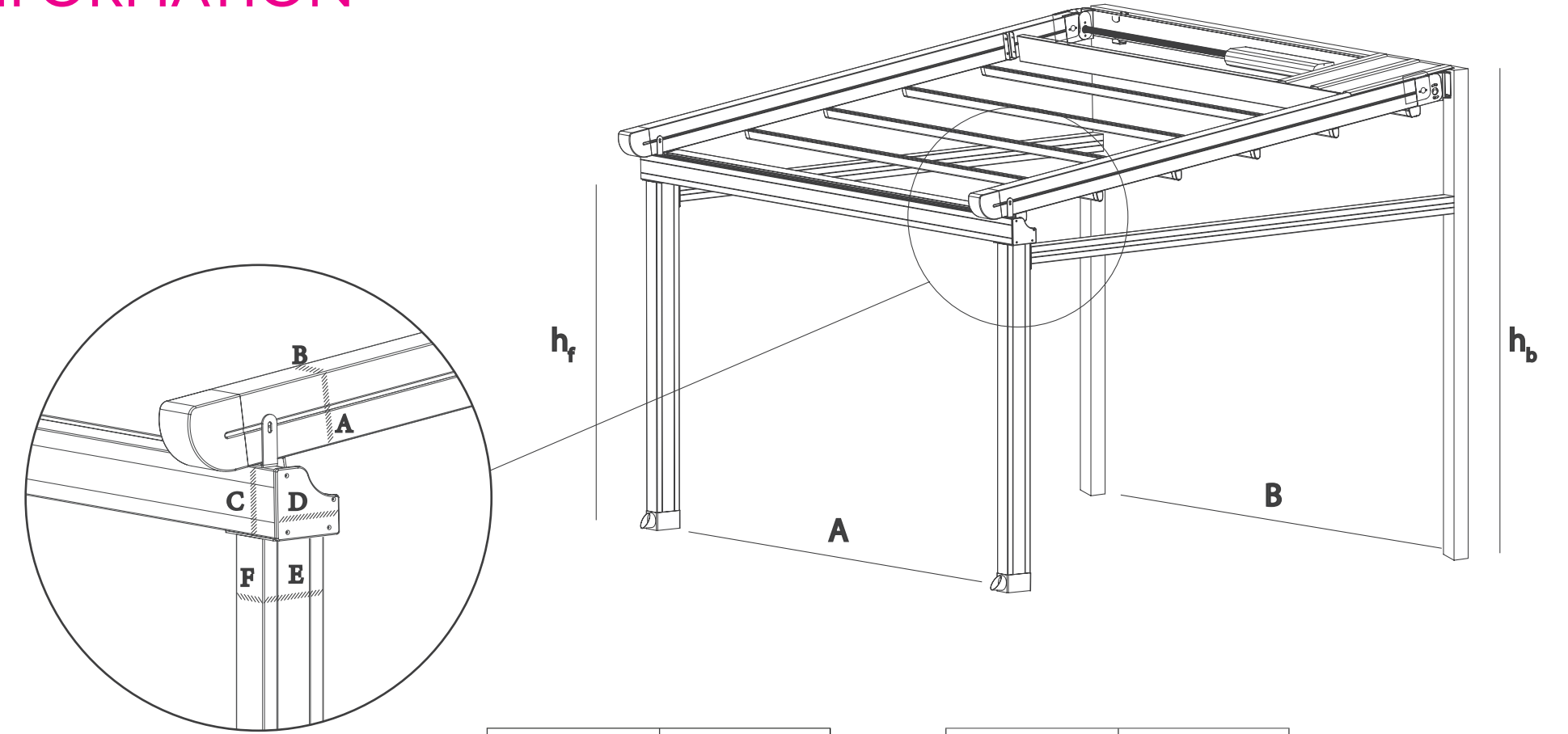

h_f - Front Height
h_b - Back Height
A - Between Front Pillars
B - Between Back Pillars

	LOCA - 1600 SERIES	LOCA - 1200 SERIES
A	160 mm	120 mm
B	110 mm	70 mm
C	150 mm	130 mm
D	160 mm	120 mm
E	100 mm	65 mm
F	160 mm	120 mm

	Aluminium Cons. 1600-1200 Series	Steel Cons. 1600-1200 Series
A	4500 mm	9000 mm
B	4500 mm	9000 mm
h _f	3000 mm	4500 mm
h _b	4500 mm	6000 mm



Twin Standing System Iclined

	1600 Series		1200 Series	
Width	1300	cm	1300	cm
Projection	2000	cm	1200	cm
Rail Aks	450	cm	450	cm

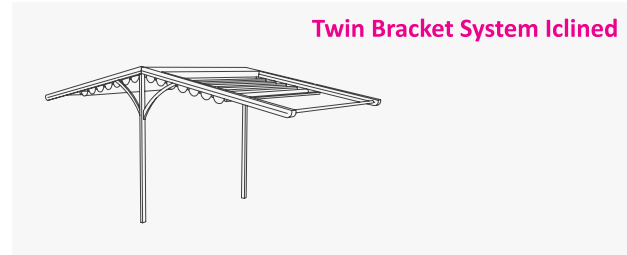

Twin Bracket System Iclined

	1600 Series		1200 Series	
Width	450	cm	450	cm
Projection	800	cm	800	cm
Rail Aks	450	cm	450	cm



Twin Hanging System Iclined

	1600 Series		1200 Series	
Width	1300	cm	1300	cm
Projection	1200	cm	1200	cm
Rail Aks	450	cm	450	cm

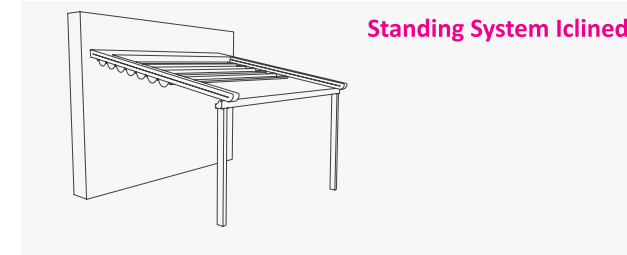

Standing System Iclined

	1600 Series		1200 Series	
Width	1300	cm	1300	cm
Projection	1000	cm	600	cm
Rail Aks	450	cm	450	cm

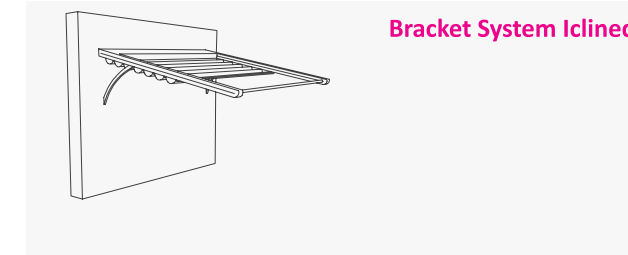

Bracket System Iclined

	1600 Series		1200 Series	
Width	450	cm	450	cm
Projection	400	cm	400	cm
Rail Aks	450	cm	450	cm

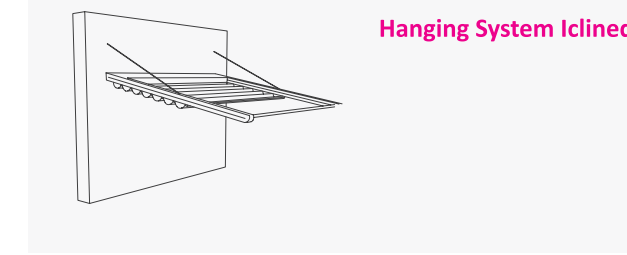

Hanging System Iclined

	1600 Series		1200 Series	
Width	1300	cm	1300	cm
Projection	600	cm	600	cm
Rail Aks	450	cm	450	cm



Twin Standing System Rounded

	1600 Series		1200 Series	
Width	1300	cm	1300	cm
Projection	1500	cm	1200	cm
Rail Aks	400	cm	400	cm



Twin Bracket System Rounded

	1600 Series		1200 Series	
Width	400	cm	400	cm
Projection	800	cm	800	cm
Rail Aks	400	cm	400	cm



Twin Hanging System Rounded

	1600 Series		1200 Series	
Width	1300	cm	1300	cm
Projection	1200	cm	1200	cm
Rail Aks	400	cm	400	cm

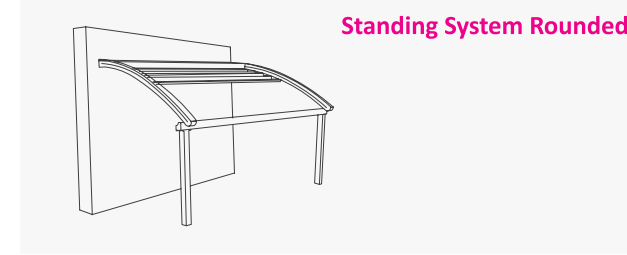

Standing System Rounded

	1600 Series		1200 Series	
Width	1300	cm	1300	cm
Projection	750	cm	600	cm
Rail Aks	400	cm	400	cm

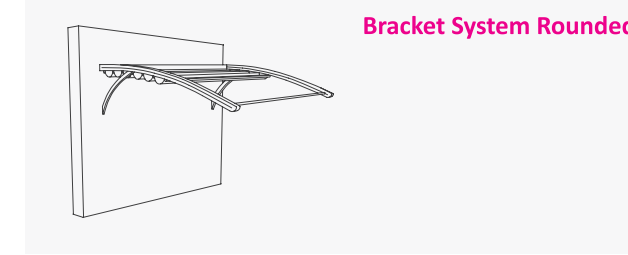

Bracket System Rounded

	1600 Series		1200 Series	
Width	400	cm	400	cm
Projection	400	cm	400	cm
Rail Aks	400	cm	400	cm

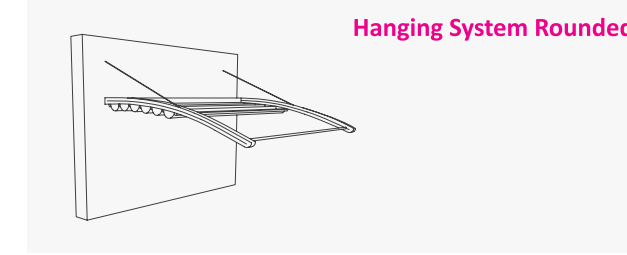

Hanging System Rounded

	1600 Series		1200 Series	
Width	1300	cm	1300	cm
Projection	600	cm	600	cm
Rail Aks	400	cm	400	cm



Twin Standing System Flat

	1600 Series		1200 Series	
Width	900	cm	900	cm
Projection	2000	cm	1200	cm
Rail Aks	450	cm	450	cm



Twin Bracket System Flat

	1600 Series		1200 Series	
Width	450	cm	450	cm
Projection	800	cm	600	cm
Rail Aks	450	cm	450	cm



Twin Hanging System Flat

	1600 Series		1200 Series	
Width	900	cm	1300	cm
Projection	1200	cm	1200	cm
Rail Aks	450	cm	450	cm



Standing System Flat

	1600 Series		1200 Series	
Width	900	cm	900	cm
Projection	1000	cm	600	cm
Rail Aks	450	cm	450	cm

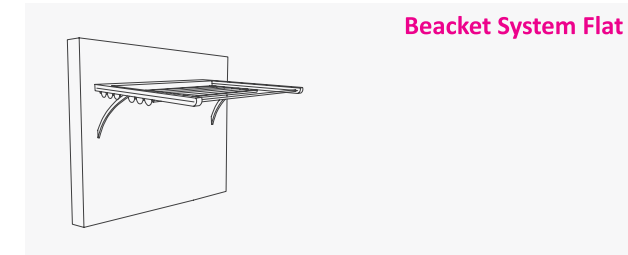

Bracket System Flat

	1600 Series		1200 Series	
Width	450	cm	450	cm
Projection	400	cm	400	cm
Rail Aks	450	cm	450	cm

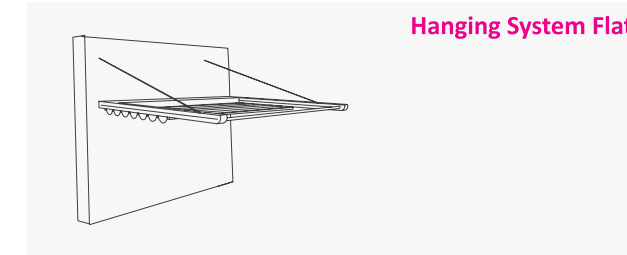

Hanging System Flat

	1600 Series		1200 Series	
Width	900	cm	900	cm
Projection	600	cm	600	cm
Rail Aks	450	cm	450	cm



www.facebook.com/diba.ts



www.instagram.com/diba.ts



www.linkedin.com/company/dibatensile-architecture



www.google.com/+DibaTSCo



www.pinterest.com/dibats

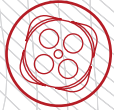

<http://www.aparat.com/dibats>



+98 919 8900184

DIBA GROUP

